



# **GPE**

*Vendors*

---

## **GPE Products s.r.l.**

Via Toniolo, 19  
61012 - Fano (PU)  
Tel. +39 0721 854 535  
Fax +39 0721 855 200  
[www.gpe.it](http://www.gpe.it)  
[gpe@gpe.it](mailto:gpe@gpe.it)



## **CATALOGO RICAMBI**

Distributore Automatico Gelati  
**- GPE Maxi Store**

---

# INDICE

TAVOLA 9-1



TAVOLA 9-2



TAVOLA 9-3

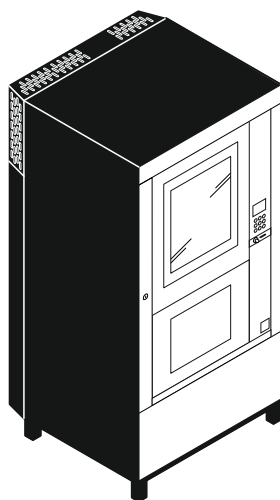

TAVOLA 9-4

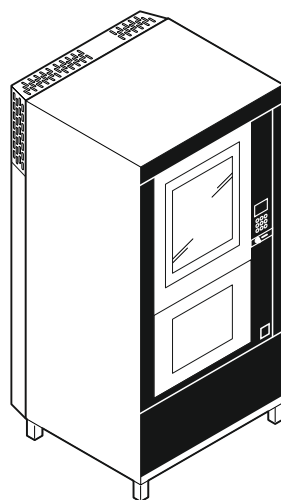

TAVOLA 9-5

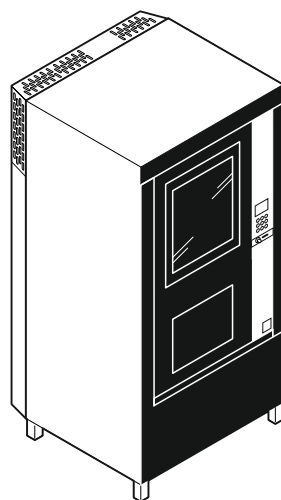

TAVOLA 9-6

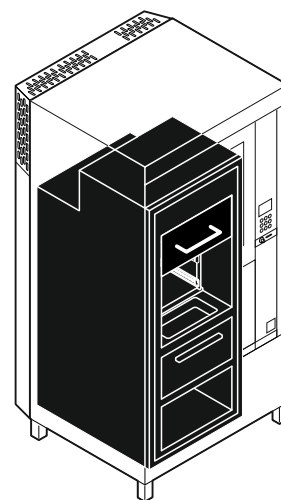

TAVOLA 9-7



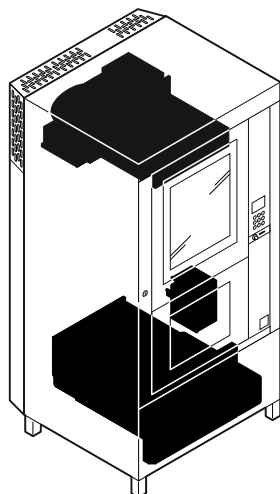



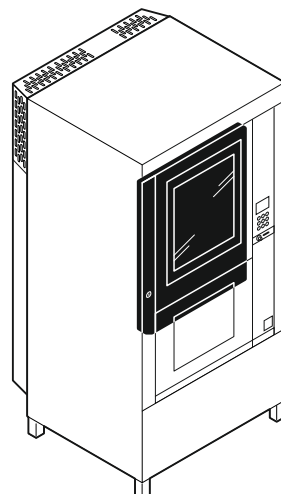
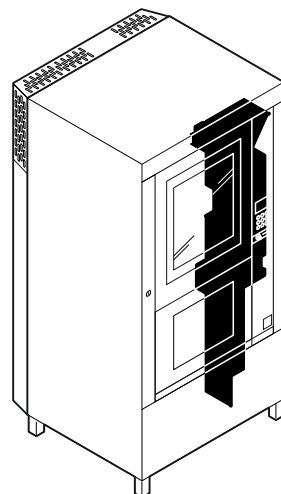
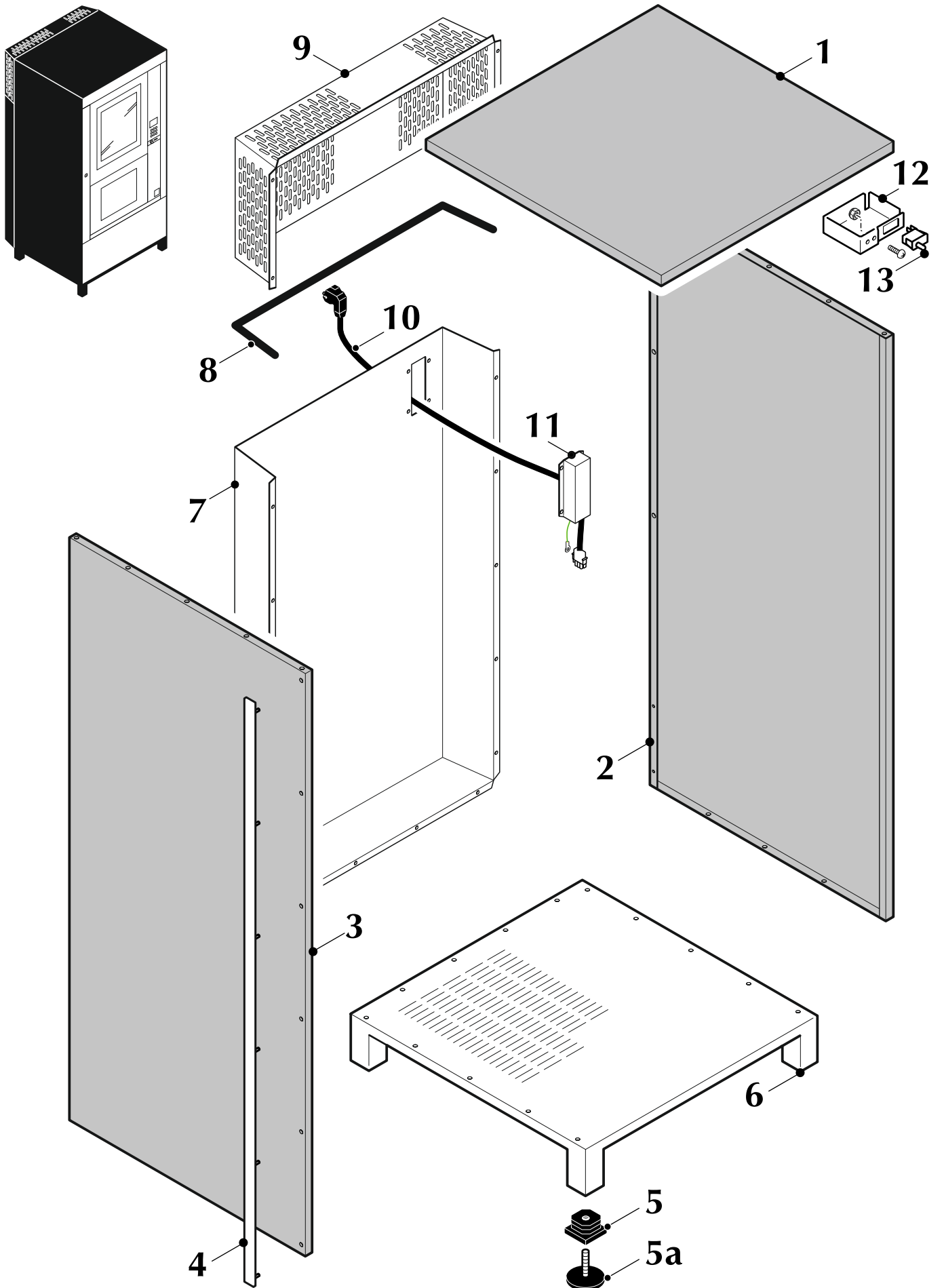
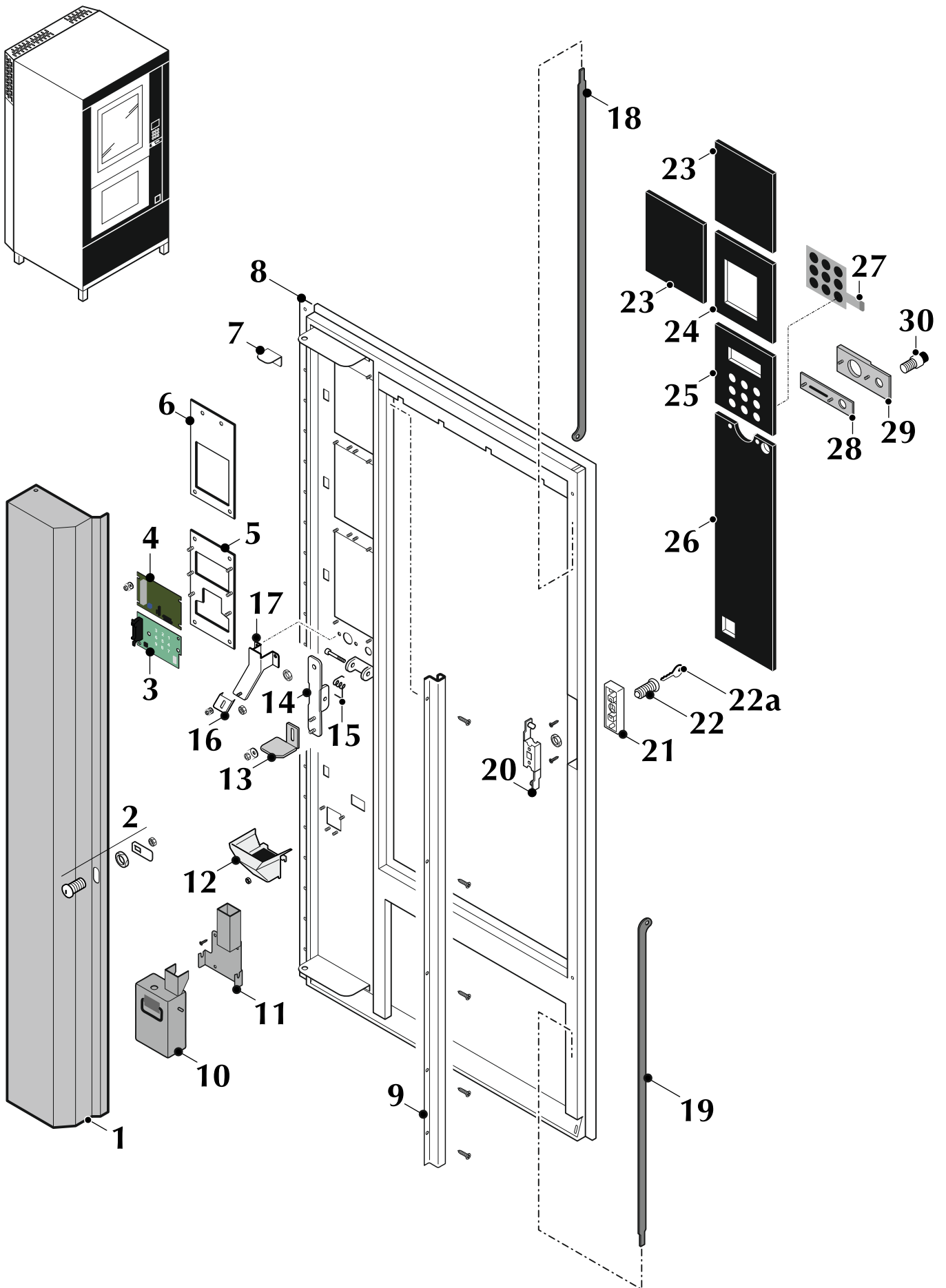
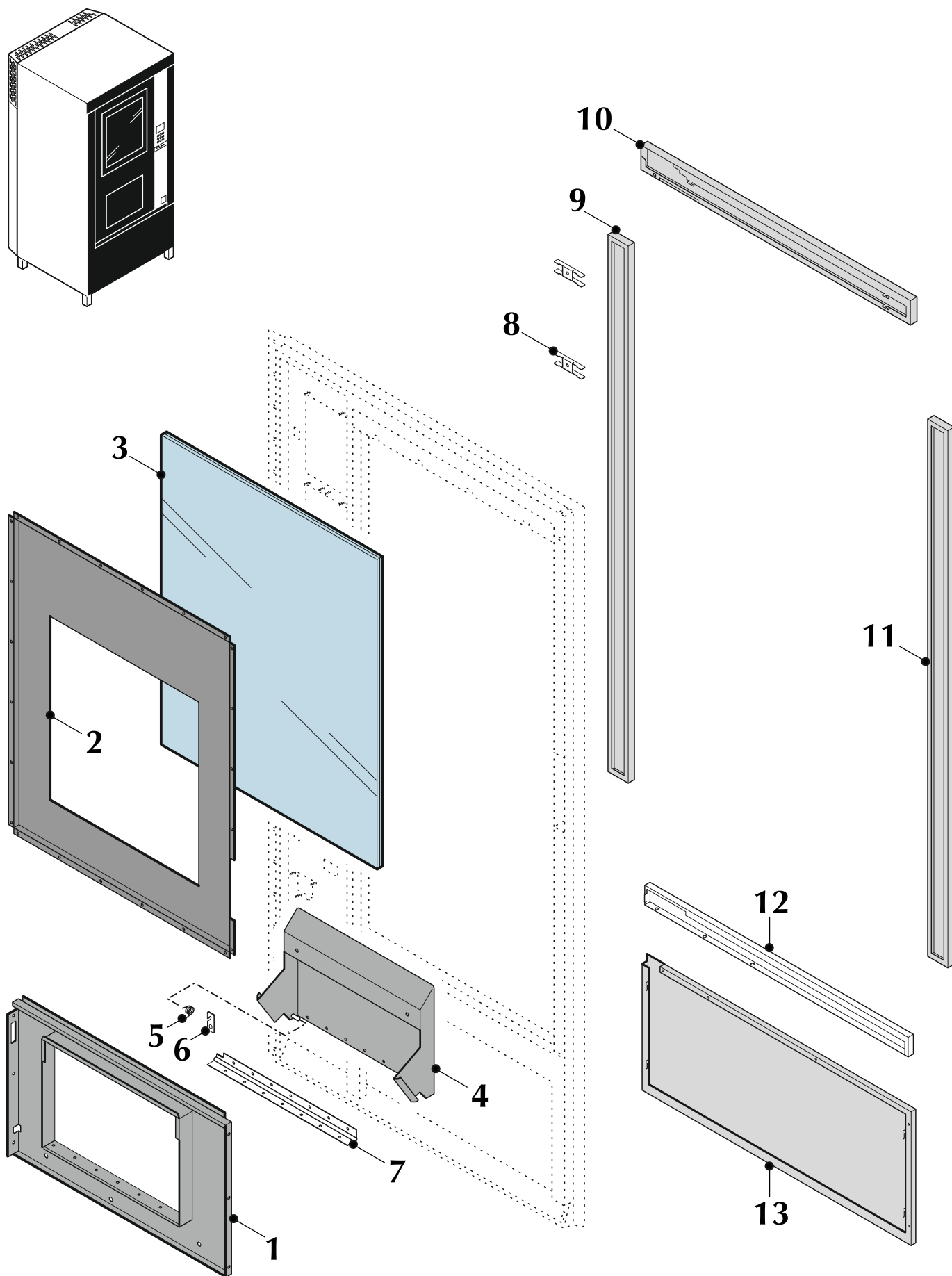

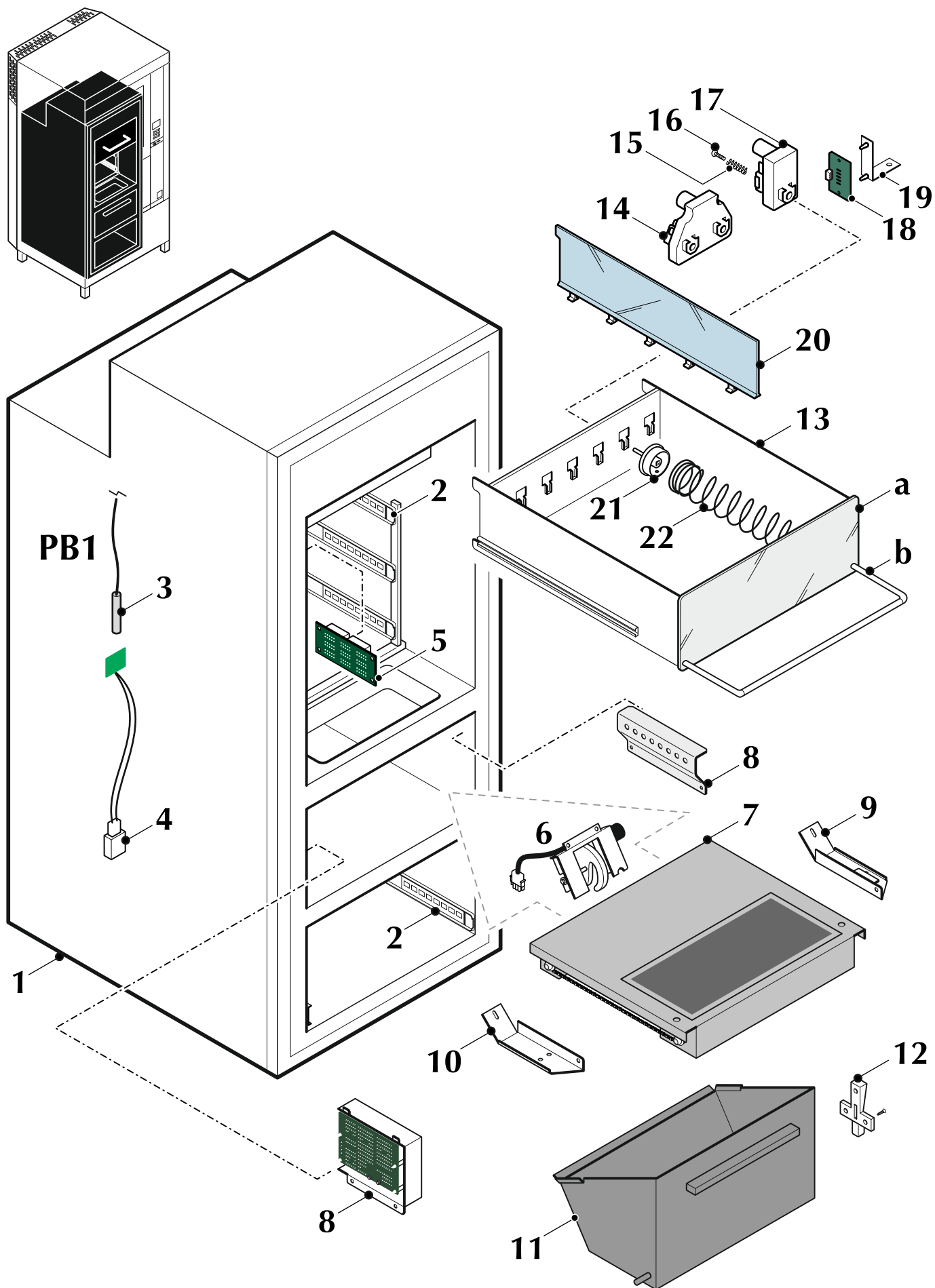

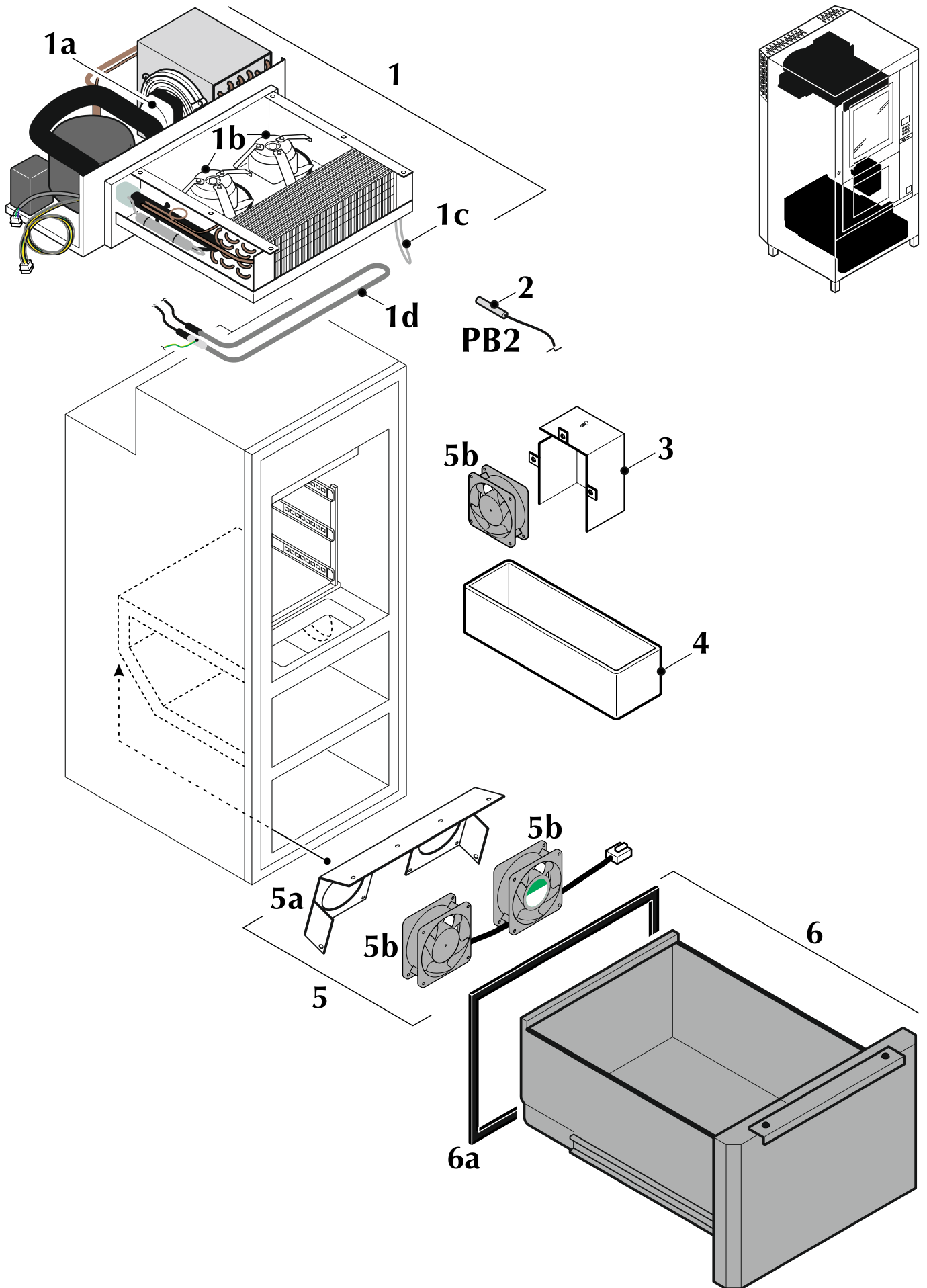

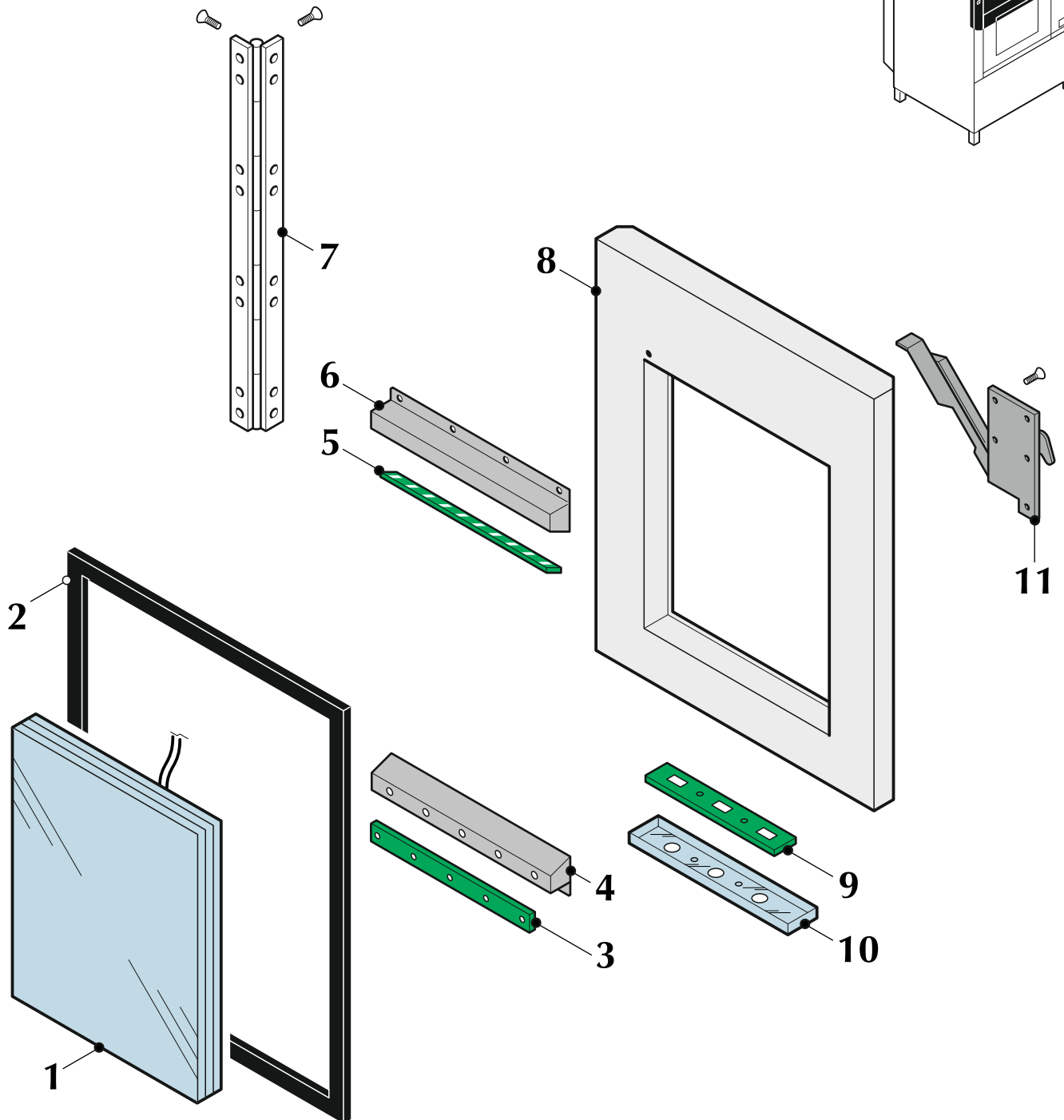
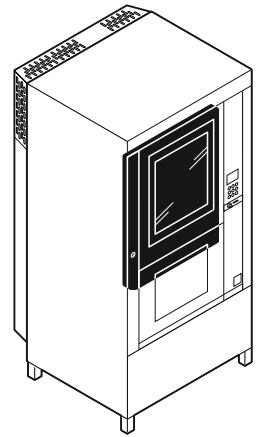

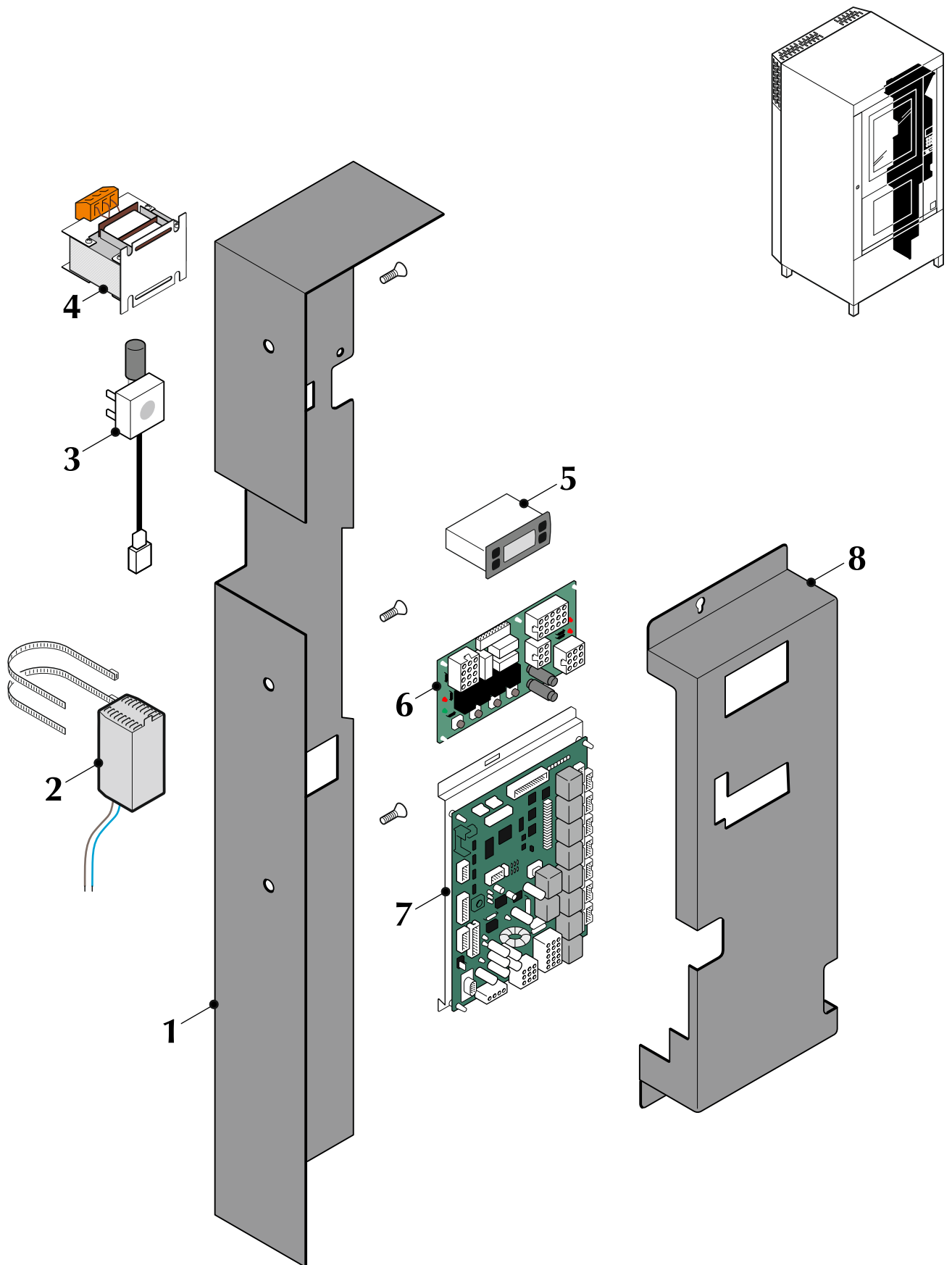

# **GPE** *Vendors*

---

## **GPE Products s.r.l.**

Via Toniolo, 19  
61012 - Fano (PU)  
Tel. +39 0721 854 535  
Fax +39 0721 855 200  
[www.gpe.it](http://www.gpe.it)  
[gpe@gpe.it](mailto:gpe@gpe.it)

---